

ENGINEERED FLOORING



econfloor

P O L S K A S P. Z O. O.

T H E N E W G E N E R A T I O N O F F L O O R S



Table of contents

| ENGINEERED FLOORING

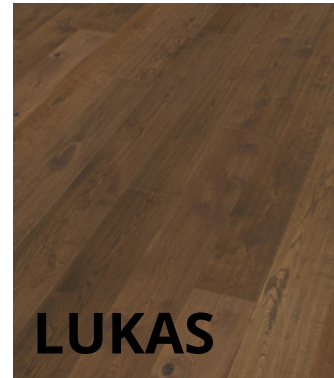
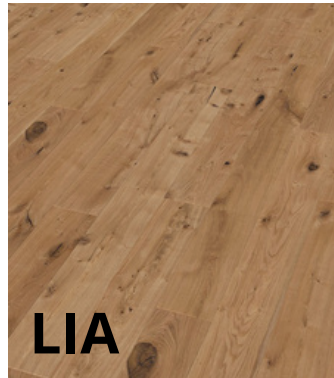

INFORMATION

Rustic-style floorboards are the kings of parquet flooring. Due to their format, they look particularly stylish and noble. They once adorned the castles of our ancestors as solid plank flooring. Today they can have many different facets, and, on the one hand, look as majestic as they did back then, and, on the other, have a designer and modern look.

If you like a particularly stylish atmosphere, our rustic-style floorboards are exactly what you are looking for. Rustic-style floorboards create a unique and noble look, whilst giving a special touch to the areas in which they have been used. Oak boards in various colours and designs are currently very popular. Oiled or varnished, modern or rustic – you will definitely find what you are looking for!

CLASSIFICATION OVERVIEW

	FAMOUS= F	VALENCIA= V	CARACAS= U	VIENNA= I
Classification	natural colour and texture differences	colour and texture differences from natural to vivid	vivid colour and texture differences	very visible to natural colour and texture differences
Well-defined knots	diameter up to 35 mm	permissible without limitation	permissible without limitation	permissible without limitation
Black knots, blurred, cracked knots	diameter up to 25 mm	diameter up to 55 mm	diameter up to 85 mm	diameter up to 85 mm limit
Blurred knot holes	diameter up to 20 mm	diameter up to 25 mm	diameter up to 40 mm	diameter up to 40 mm
Fibre pattern of wear layer	free	free	free	free
Medullary rays	permissible without limitation	permissible without limitation	permissible without limitation	permissible without limitation
Sapwood	permissible at the edge	permissible without limitation	not permissible on transparent surface – permissible at the edge with coloured surface	permissible without limitation
Blurred cracks	permissible up to 3 mm wide and 200 mm long	permissible up to 6 mm wide and 200 mm long	permissible up to 600 mm long	permissible up to 600 mm long

KASIA

**Oak Famous Grading, oiled, brushed, 4-sided bevelled
Click-System 5G**

Length: 1900 mm

Width: 190 mm

Thickness: 15 mm

Top Layer: 4 mm



GEORGE

**Oak Caracas Grading, oiled, brushed, 4-sided bevelled
Click-System 5G**

Length: 1900 mm

Width: 190 mm

Thickness: 15 mm

Top Layer: 4 mm

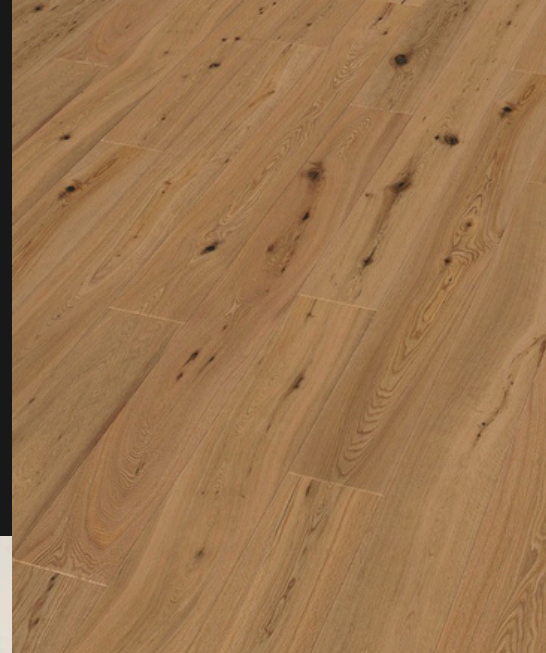

MARIA

**OAK CARACAS Grading, oiled, smoked, heavily brushed,
4 sided bevelled
Click-System 5G**

Length: 1900 mm
Width: 190 mm
Thickness: 14 mm
Top Layer: 3 mm



JOLA

**OAK WHITE FAMOUS Grading, oiled, white pigmented, brushed,
4 sided bevelled
Click-System 5G**

Length: 1900 mm

Width: 190 mm

Thickness: 15 mm

Top Layer: 4 mm



LENA

OAK CARACAS Grading, oiled, brushed
4 sided bevelled
Click-System 5G

Length: 1900 mm
Width: 190 mm
Thickness: 14 mm
Top Layer: 3 mm



LIA

OAK CARACAS Grading, oiled, hand planed
4 sided bevelled
Click-System 5G

Length: 1900 mm
Width: 190 mm
Thickness: 14 mm
Top Layer: 3 mm



LUKAS

**OAK Famous Grading, oiled, robust, hand planed,
4 sided bevelled
Click-System 5G**

Length: 2200 mm
Width: 260 mm
Thickness: 15 mm
Top Layer: 4 mm



DOM

OAK CARACAS Grading, oiled, white pigmented, brushed
4 sided bevelled
Click-System 5G

Length: 1900 mm

Width: 190 mm

Thickness: 14 mm

Top Layer: 3 mm



JANEK

OAK Famous Grading, oiled, white pigmented, brushed
4 sided bevelled
Click-System 5G

Length: 2200 mm
Width: 260 mm
Thickness: 15 mm
Top Layer: 4 mm



HANIA

OAK Famous Grading, oiled, brushed
4 sided bevelled
Click-System 5G

Length: 2200 mm
Width: 260 mm
Thickness: 15 mm
Top Layer: 4 mm

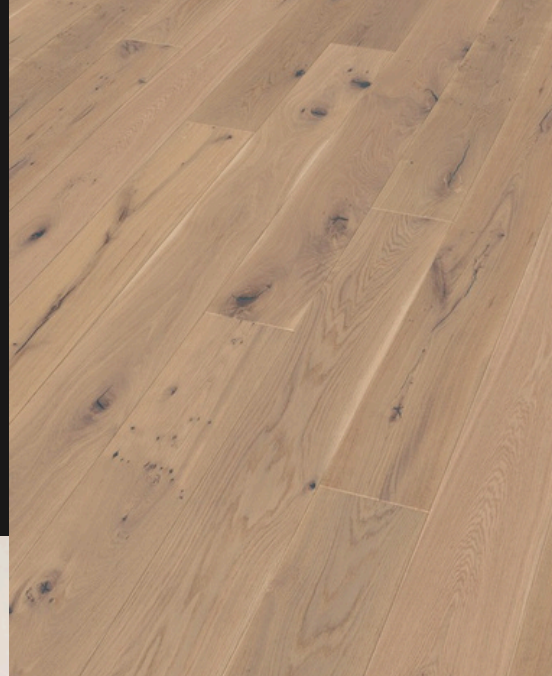





Table of contents

| HERRINGBONE PARQUET



| HERRINGBONE PARQUET

Tradition in modern style

Modern interiors combined with classic herringbone flooring gain a unique character and create a special atmosphere.

Optilook joint is a new joint that allows the classic herringbone pattern to be laid accurately, quickly and easily. Thanks to the profile of the joint, the pattern can be laid without using the right and left board. It also enables floating installation.

A classic among installation patterns, herringbone stands for a timeless parquet that can be combined with any interior style. Herringbone flooring is created by arranging parquet blocks in a way that makes them resemble the pattern of fir needles. Due to the varying laying directions of the herringbone pattern, the light always refracts in a different way, which gives this floor its unique character.

FLIPPER

Herringbone oak

Dimensions: 130 x 725 x 14 mm

Wear layer: 2.5 mm thick

Surface: brushed with 4-sided microbevelling and oxi oiling

Installation system: Optilock

Look: Caracas classification



MEG

Herringbone ash

Dimensions: 130 x 725 x 14 mm

Wear layer: 2.5 mm thick

Surface: 4-sided micro bevelling and matt varnish

Installation system: Optilock

Look: Famous classification



NEMO

Herringbone oak

Dimensions: 130 x 725 x 14 mm

Wear layer: 2.5 mm thick

Surface: brushed with 4-sided micro bevelling and matt varnish

Installation system: Optilock

Look: Famous classification



WANDA

Herringbone oak

Dimensions: 130 x 725 x 14 mm

Wear layer: 2.5 mm thick

Surface: brushed with 4-sided micro bevelling and matt varnish

Installation system: Optilock

Look: Caracas classification



WHITE SHARK

Herringbone oak

Dimensions: 130 x 725 x 14 mm

Wear layer: 2.5 mm thick

Surface: brushed with 4-sided micro bevelling and matt varnish

Installation system:

Look: Caracas classification



WILLY

Herringbone oak

Dimensions: 130 x 725 x 14 mm

Wear layer: 2.5 mm thick

Surface: brushed with 4-sided micro bevelling and oxi oiling

Installation system: Optilock

Look: Caracas classification





| Ship deck floor/three-strip

Parquet flooring with ship deck look is suitable for various areas in a house or flat. However, this pattern looks particularly good in smaller rooms. Rustic boards over 2 meters long can also be installed, but due to its slightly lower price, ship deck flooring seems to be a better choice.

Individual segments of this parquet provide a great variety and dynamic even in smaller rooms:

Here, dark brown boards follow slightly lighter ones; rustic boards more harmonious areas; and matt slightly shiny ones.

A ship deck floor can usually be laid without joints or bevel on the sides; individual parquet boards lie directly next to each other without gaps. Thanks to this, the parquet surface is particularly homogeneous, whereas the direction of installation is of secondary importance – you are allowed to do what you like!

SKIRTING BOARDS



Oak 40
Dimensions: 2200 x 40 x 16 mm
Look: natural varnished oak



Oak 60
Dimensions: 2200 x 60 x 16 mm
Look: natural varnished oak



White Skirting Boards
Dimensions: 2400 x 70 x 16 mm
Look: MDF, white foiled

ACCESSORIES

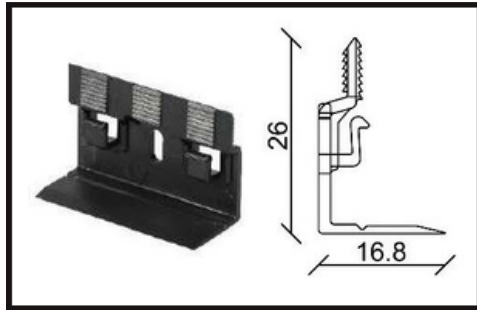

CLIPHOLDER
for skirting boards
Structure: Plastic

30 pcs per pack
Calculate 3-4 pcs. per metre

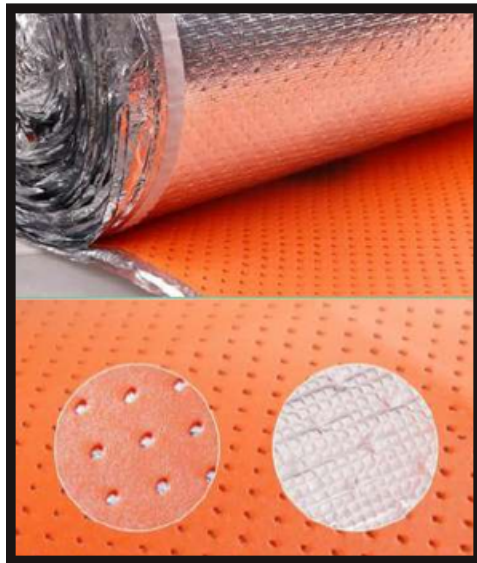

IMPACT SOUND INSULATION

L: 7m

W: 1m

Thickness: 2mm

Perfect for floor heating



GLUE

12kg/ packaging

Suitable for floor heating



econ  floor

P O L S K A S P. Z O. O.

T H E N E W G E N E R A T I O N O F F L O O R S





econfloor

P O L S K A S P. Z O O.
THE NEW GENERATION OF FLOORING



Head office:
ul. Grel 77
34-471 Ludźmierz, Polska

 sale@econfloorpolska.com  +48 182 005 180  www.econfloorpolska.com